

# Digital Video Recorder



## User Manual

Please read this instructions thoroughly before operation and retain it for future reference.



November 2004 V 1.2

EV-D1660

[www.eurovideo-cctv.com](http://www.eurovideo-cctv.com)

[www.eurovideo-cctv.com](http://www.eurovideo-cctv.com)

## WARNING

*All the safety and operating instructions should be read before operation. The improper operation may cause permanent damage.*

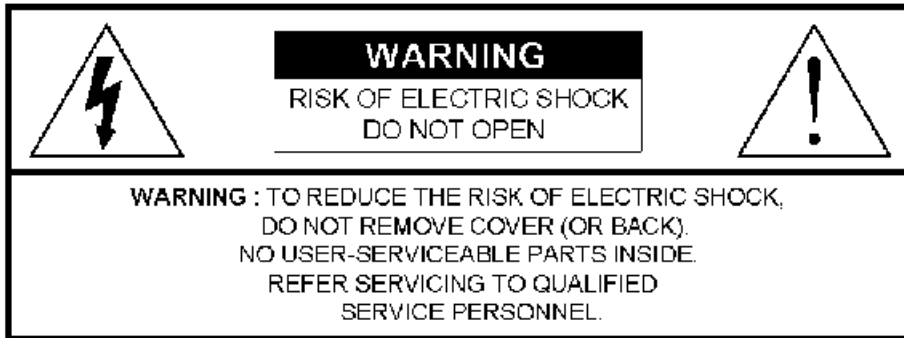

- Please use the provided adaptor (Other adaptor is not suitable for this machine).
- Please lift and place this equipment gently.
- Do not expose this equipment to open sunlight.
- Do not use this equipment near water or in contact with water.
- Do not spill liquid of any kind on the equipment.
- Please power down the unit before unplugging.
- Do not switch the Power On & Off within short period of time (within 3 seconds).
- Do not attempt to service this equipment by yourself.
- Installation should be made by qualified service personnel.



The lightning flash with arrowhead symbol, within an equilateral triangle, is intended to alert the user to the presence of uninsulated "dangerous voltage" within the product's enclosure that may be of sufficient magnitude to constitute a risk of electric shock to persons.



The exclamation point within an equilateral triangle is intended to alert the user to the presence of important operating and maintenance-(servicing) instructions in the literature accompanying the appliance.

## TABLE OF CONTENTS

### What do you get ?

- FEATURES ----- 3
- PACKAGE INCLUDING ----- 3

### Before Operation

- INSTALLATION GUIDE ----- 4
- FRONT PANEL ----- 5
- BACK PANEL ----- 7

### Basic Operation

- START THIS UNIT ----- 8
- OPERATION ----- 8

### Detailed Menu Setup

- ACCESS MENU ----- 10
- MAIN MENU ----- 10
- MENU OPTIONS ----- 11
- MOTION DETECTION ----- 15

### Advanced Operation

- OPERATION OPTIONS ----- 17
- KEY LOCK ----- 18
- RS-232 PROTOCOL ----- 18
- Trouble Shooting ----- 19
- Specifications ----- 19
- APPENDIX #1 – INSTALLING THE HDD ----- 20
- APPENDIX #2 – PIN CONFIGURATIONS ----- 22
- APPENDIX #3 – RACK MOUNT ----- 24
- APPENDIX #4 – RECORDING SPEED ----- 25

## FEATURES

### DVR Features

- Wavelet Compression Format replaces Time-Lapse VCR + Multiplexer
- 4 Audio inputs / 2 Audio outputs
- On Screen Display and RTC (Real time clock) Function
- Support from 4 channel to 7/9/10/13/16 channels video inputs
- Picture-In-Picture (PIP) is available in live and DVR playback modes
- Motion detection function and 4 Level video quality adjustable on each channel
- Alarm Input & Output Function
- Video loss detected on each channel can record 160 events
- Power-loss memory function
- Support 2 Removable HDDs, IDE Type
- Quick Multiple Search by date/time, alarm, full list
- Security password protection
- RS-232, RS-485 communication protocol

## PACKAGE INCLUDING



Digital Video Recorder with HDD cartridge)



User Manual



Accessories pack



2 Keys for Cartridge



Power Adapter and Cord

**NOTE : Please check the package to make sure that you receive the complete accessories which includes the components shown above.**

## INSTALLATION GUIDE

1. Connect cameras and monitor with the DVR.
2. Shown below is one example for connecting the DVR to your existing Observation System.
3. Install HDDs (The compatible HDD Brands are listed in the following table.)

Please refer to page.20 Appendix #1 for installation instructions.

The HDDs must be installed before turning on the DVR.

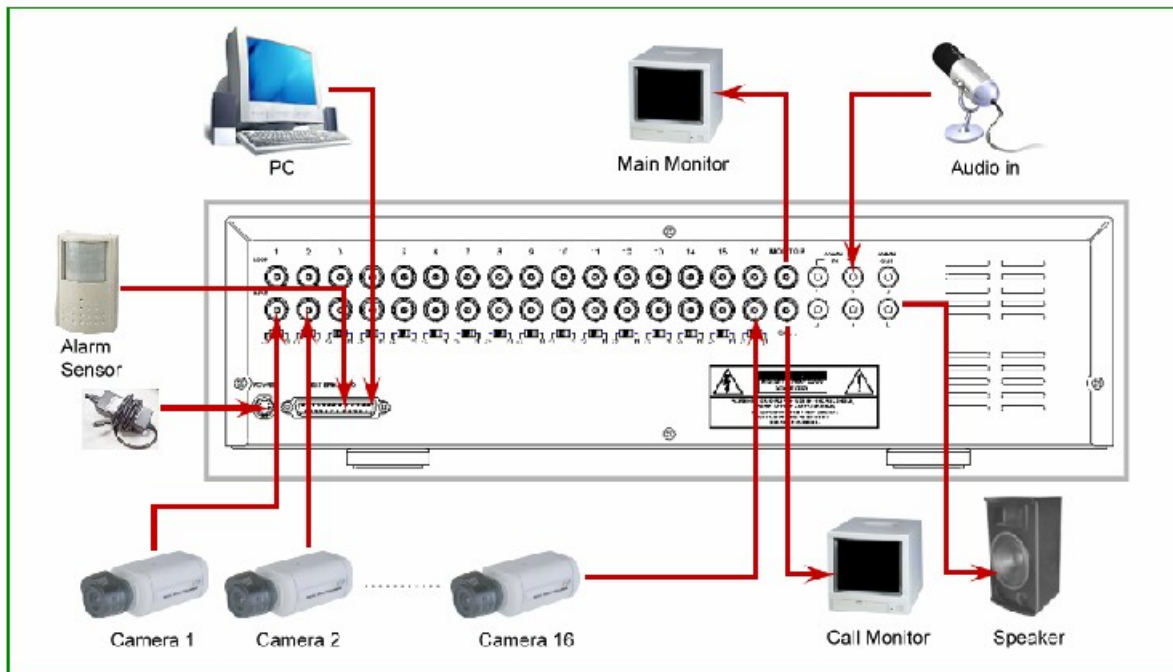

### COMPATIBLE HARD DISK BRANDS

Manufacturer	Model	Capacity	Rotation
HITACHI	Deskstar 180 GXP (120 GB)	120GB	7200 rpm
HITACHI	Deskstar 7K250, HDS722516VLAT20	160GB	7200rpm
HITACHI	Deskstar 7K250, HDS722525VLAT80	250GB	7200rpm
IBM	Deskstar 120GXP (80GB)	80GB	7200 rpm
IBM	Deskstar 120GXP (120GB)	120GB	7200 rpm
Maxtor	DiamondMax 536DX(60GB) 4W060H4	60GB	5400rpm
Maxtor	DiamondMax Plus 9	80GB	7200 rpm
Maxtor	DiamondMax Plus 9, Model#6Y120L	120GB	7200 rpm
Maxtor	DiamondMax Plus 9, Model#6Y160L0	160GB	7200rpm
Seagate	Barracuda ATA IV, ST380021A	80GB	7200rpm
Seagate	Barracuda ATA V, ST3120023A	120GB	7200 rpm
Seagate	Barracuda 7200.7 Plus, ST3160023A	160GB	7200 rpm
Western Digital	Caviar WD1200BB-00CAA1	120GB	7200rpm
Western Digital	Caviar WD2000BB-00DWA0	200GB	7200rpm

## FRONT PANEL

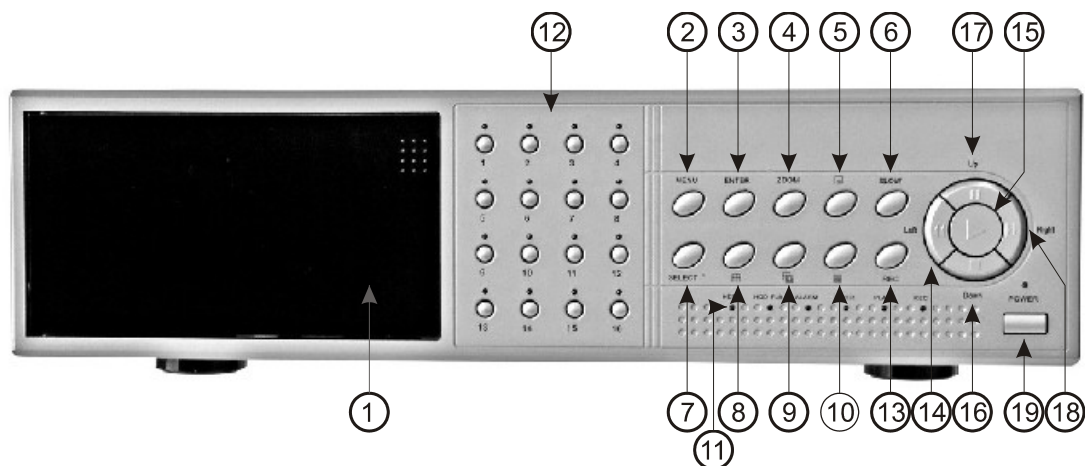

### 1. REMOVABLE HDD CARTRIDGE

Please refer to page.20 Appendix #1.

### 2. MENU

Press MENU to enter main menu.

### 3. ENTER

Press ENTER for confirmation.

### 4. ZOOM

Press ZOOM to enlarge the picture display.

### 5.

Press PIP button for Picture in Picture screen.

### 6. SLOW

To slow down speed of play mode.

### 7. SELECT

Press the Select to select appointed camera (1~16) to display on full screen mode.

### 8.

4 channels display mode

9.   
7, 9, 10, 13 channels display mode

10.   
16 channels display mode

### 11. LED LIGHT

The LED Light is ON under following condition.

- HDD : HDD is activated
- HDD Full : HDD is full
- ALARM : If you want to turn off the ALARM LED light, please refer to page.14 and set the Camera / ALARM item as OFF. (all of the cameras should be set as OFF.)
- TIMER : When Timer is set as Enabled
- PLAY : On Play mode
- REC : On Recording mode

### 12. CAMERA (1-16)

Press the Camera Select (1-16) to select specified camera.

### 13. REC

Press REC to start recording.

### 14. REW / LEFT

- REW : Under DVR play mode, it can play video backward at different speeds. (Press REW again to adjust speed as 1, 2, 4, 8, 16, 32 times)
- Left : Under setup mode, it works as Left button.

### 15. PLAY

Press PLAY to play recorded video.

### 16. STOP / DOWN

- STOP : Under DVR Record / Play mode, it can stop the moment action.
- DOWN : Under setup mode, it works as Down button.

### 17. PAUSE / UP

- Pause : Under DVR play mode, it can pause the action.
- UP : Under setup mode, it works as Up button.

### 18. FF / Right

- FF : It can play video forward at high speed, and press FF again to adjust speed from 1, 2, 4, 8, 16, 32 times.
- Right : Under setup mode, it can work as Right button.

### 19. POWER

Press Power to turn ON / OFF the DVR.

## BACK PANEL

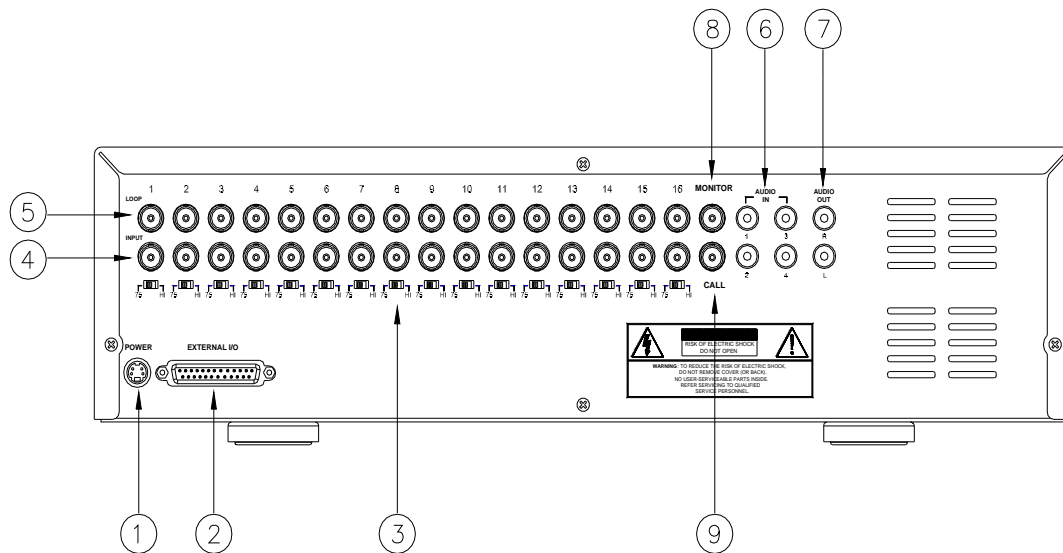
**1. POWER**

Please use the provided adaptor to connect power cord (Other adaptor is not suitable for this machine).

**2. EXTERNAL I/O**

- Controlled remotely by an external device or control system.
- Alarm input, external I / O explanation.

**3. 75Ω / HI**

When using Loop function, please switch to **HI**. If you don't use Loop function or disconnect the video input, please set it as **75Ω**.

**4. VIDEO INPUT (1-16)**

Connect to video source, such as camera.

**5. LOOP (1-16)**

Connect video signal between Input port and Loop port to make a loop.

**6. AUDIO IN (1-4)**

Connect to audio source, such as microphone.

- IPS should be set to 25A (for NTSC) or 18A (for PAL)

\* 4 audio inputs, but only can select 1 during recording.

**7. AUDIO OUT (R/L)**

Connect to monitor or speaker.

- IPS should be set to 25A (for NTSC) or 18A (for PAL)

\* with 2 mono audio outputs from the same source.

**8. MONITOR**

Connect to Main monitor

**9. CALL**

Connect to CALL monitor. Show the Switch Display. When alarm trigger happens, the call monitor will show the triggered channel for a period of time.



## START THIS UNIT

Before using the DVR, please have the HDDs installed ready. (refer to Appendix #1 for installation or removal of HDDs).

1. Connect the AC Power Cord with Power Adapter and plug into an electrical outlet. The Red LED indicator light will be ON and the DVR is in Standby mode.
2. Press the Power button. The POWER LED will turn from red to orange, and other red LED indicators will turn ON. It takes approximately 5 to 15 seconds to boot the system with the message : " HDD Detecting ". Once connected, the POWER LED will change to green color, and the Alarm LED will be ON.
3. Before operating the DVR, please set up the system time first. (for setting system time, please refer to page.11).

**NOTE : When "HDD not found" message shows up, please refer to appendix # 1. As the HDD is likely not installed correctly.**

## OPERATION

### RECORDING

The DVR offers a variety of recording modes, such as record continuously, at scheduled time, and by events. You can set up recording speed and resolution. You can set these options by selecting MENU / RECORD before recording, please refer to page.14. Under the recording status, if power is off accidentally, recorded video will still store in the HDDs. DVR will return to original recording situation after power returns again.

On the screen, you will find the date, time, HDD recording type, the amount of available GB left in the HDDs memory and the letter "M" represents the method of recording that is occurring.

(OW : HDD Overwrite)

**NOTE : 1. When the HDDs are full under O/W Recording mode, previous recorded files may be overwritten without further warning notices.**

**2. XXGB at the left side means the left space in the Master HDD and at the right side means the left space in the Slave HDD.**

**3. If the HDDs' capacity is only 5 GB left, it will buzz for 3 seconds; so as in 4GB, 3GB, 2GB and 1GB. If the O/W Recording mode(NOTE 1) is on, it won't have the warning buzzer.**

2002 – JAN –01 01:02:03
M● 032GB 080GB

There are 4 recording modes in which Recording can occur : Alarm, Timer and Manual Record.

#### 1. ALARM RECORD

DVR is triggered by an alarm input. Indicated by the letter "A" and show  diagram on the triggered channel.

#### 2. TIMER RECORD

Recording is scheduled by a Timer. Indicated by the letter "T".

#### 3. MANUAL RECORD

Recording is initiated by manually pressing the REC button. Indicated by the letter "M".

#### 4. MOTION TRIGGER RECORD

Recording is triggered by motion detection. Indicated by the letter "D" and show  diagram on the triggered channel.

## PLAY

Press "PLAY" button, the DVR will show the last recording.

### **1. FAST FORWARD (F.F.) & FAST REWIND (F.R.)**

You can increase the speeds of Fast Forward and Rewind on the DVR.

In the Play mode, press "▶▶" once to get 2X speed forward and press twice to get 4X speed,... and the maximum speed can reach 32X.

Press "◀◀" once to get 1X speed rewind and press twice to get 2X speed, ... and the maximum speed can reach 32X.

### **2. SLOW FORWARD (S.F.) & SLOW REWIND (S.R.)**

You can also slow down the speeds of Forward and Rewind on the DVR.

In the Play mode, press the SLOW button and you will enter Slow mode.

Press "▶▶" once to get 1/2X speed forward and press twice to get 1/4X speed,... and the slowest speed can reach 1/32X.

Press "◀◀" once to get 1/2X speed rewind and press twice to get 1/4X speed, ... and the slowest speed can reach 1/32X.

### **3. PAUSE**

It will let you pause the current image displayed on the screen.

### **4. STOP**

Press "STOP" under any circumstance, it will return DVR to live monitoring mode.

### **5. IMAGE JOG DIAL**

It will allow you to manually view video frame-by-frame, one image at a time.

While in PLAY mode, press "PAUSE", it will pause the screen.

Press "▶▶" button to advance the frozen screen one image forward.

Press "◀◀" button to move back one image.

## CAMERA SELECT (1--16)

*Press Camera Select (1-16) to select appointed camera to display on full screen mode.*

## ACCESS MENU

The Menu allows you to configure your DVR settings. Please follow below steps to access the Menu :

Press the Menu button. The password screen will appear:

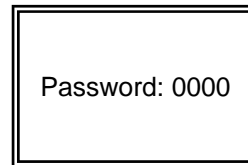

**NOTE :** The default Password is 0000. Simply press the Enter button to access the Menu.

To key-in the Password, press the “Right” and “Left” buttons to move between numbers, and use the “Up” and “Down” buttons to input the number.

Press the ENTER button once the correct Password is entered. The MENU options screen will appear.

**Note:** If you get a message “Password Error”, you have entered an incorrect password.

## MAIN MENU

There are 6 options available in the Main Menu:

**SEARCH** ----- Find recorded list  
**TIMER** ----- Scheduling Record  
**RECORD** ----- Record Mode Setup  
**CAMERA** ----- Camera Channel Setup  
**SYSTEM** ----- System Setup  
**EVENT** ----- Event List

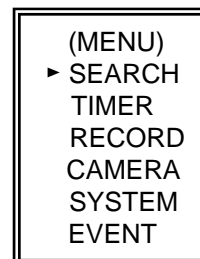

Outlined below are the buttons used for Menu setting :

- “Up” and “Down” : Scroll up and down or change values when an option is selected and is blinking
- “Left” and “Right” : Scroll sideways within a menu option that has been selected
- ENTER : Selects a submenu / an option under a submenu for browsing / modification
- MENU : Completes modification of a menu option; exits a menu

## MENU OPTIONS

### SYSTEM

#### 1. AUDIO INPUT

To choose one of 4 channels to record. (only can select 1 during operation for recording)

#### 2. INT AUDIBLE ALARM

To set the INTERNAL AUDIBLE ALARM. It will be triggered by event occurrence when the setting is ON.

#### 3. EXT AUDIBLE ALARM

To set the EXTERNAL AUDIBLE ALARM. It will be triggered by event occurrence when the setting is ON.

#### 4. MOTION AUDIBLE ALARM

To set the MOTION AUDIBLE ALARM. It will be triggered by motion detection occurrence when the setting is ON.

#### 5. ALARM DURATION

Set the reaction time which was determined by how long the alarm mode responded to a buzzer. Default setting is 10 sec. Options are 10 SEC, 15 SEC, 20 SEC, 30 SEC, 1MIN, 2MIN, 3 MIN, 5 MIN, 10 MIN, 15 MIN, 30 MIN, ALWAYS.

#### 6. DWELL TIME

DWELL TIME is the time period that each channel sequentially shown on call monitor.

#### 7. MESSAGE LATCH

To select whether the DVR messages will disappear after 10 sec or remain on screen. NO is the default setting which the messages will go away after 10 sec.

**NOTE : Video loss, Alarm and Motion messages will be shown the same as Alarm Duration time.**

#### 8. TITLE DISPLAY

To set the title shown on monitor or not.

#### 9. TIME DISPLAY

To set the time format on the DVR.

#### 10. TIME

To set the correct time on the DVR.

```
(MENU)
SEARCH
TIMER
RECORD
CAMERA
▶SYSTEM
EVENT
```

```
(SYSTEM)
▶ AUDIO INPUT : 1
INT AUDIBLE ALARM : ON
EXT AUDIBLE ALARM : ON
MOTION AUDIBLE ALARM : ON
ALARM DURATION : 10 SEC
DWELL TIME : 02 SEC
MESSAGE LATCH : NO
TITLE DISPLAY :ON
TIME DISPLAY : Y/M/D
2003-JAN-02(THU) 17:37:09
NEW PASSWORD : XXXX
CLEAR HDD : MASTER
SYSTEM RESET : NO
REMOTE MODE : RS-232
BAUD RATE : 9600
REMOTE ID : 000
```

### 11. NEW PASSWORD : XXXX (Default password : 0000)

To set the new password.

### 12. CLEAR HDD

Delete all the contents of your HDD. When you choose "YES" on this option, you will be prompted with the question shown : Press "▶" to clear HDD or press "◀" to confirm not to clear HDD.

ALL DATA IN HDD  
WILL BE CLEARED  
ARE YOU SURE?  
(◀ : NO ▶ : YES)

### 13. SYSTEM RESET

Reset all system settings to book to factory default settings.

### 14. REMOTE MODE

Set the remote mode for connection with computer via RS-232 or RS-485. (Please refer to page.18 for RS-232 Remote Protocol)

### 15. BAUD RATE

Set the remote protocol transmitting baud rate. Available Baud Rate are 115200, 57600, 19200, 9600, 4800, 3600, 2400 and 1200.

### 16. REMOTE PROTOCOL ID SETUP

To control different DVR by setting RS232 remote protocol. ID number can be set from 000 to 255.

## SEARCH

Press "ENTER" to confirm SEARCH setup, and the screen will show following options.

### 1. LAST RECORD

Play the last recorded piece of video.

### 2. FULL LIST

Show a listing of all recorded video on the HDD which sorted by time.

D : Motion Record  
M : Manual Record time  
A : Alarm Record time  
T : Timer Record time  
M-HDD : Storage in Master HDD  
S-HDD : Storage in Slave HDD

### 3. ALARM LIST

Show a listing of all recorded video triggered by an Alarm.

**NOTE : If there are no Alarm in the record, the screen will display "EMPTY".**

### 4. MOTION LIST

Show a listing of all motion detection triggered.

### 5. TIME SEARCH

Find video recorded on a specific date that is entered.

(MENU)  
▶ SEARCH  
TIMER  
RECORD  
CAMERA  
SYSTEM  
EVENT

▶M 2002-JAN-01 01:02:03 M-HDD  
M 2002-JAN-01 01:02:03 M-HDD  
A 2002-JAN-01 01:02:03 M-HDD  
T 2002-JAN-01 01:02:03 M-HDD  
D 2002-JAN-01 01:02:03 S-HDD  
M 2002-JAN-01 01:02:03 S-HDD  
◀: PAGE UP▶: PAGE DOWN

▶LAST RECORD  
FULL LIST  
ALARM LIST  
MOTION LIST  
TIME SEARCH

## TIMER

### 1. DAY

Select the day, or days of the week (Mon–Fri / Sat–Sun / Daily) that you wish to schedule the DVR to automatically record.

**NOTE** : 1.Special Date could be changed by "Enter", "Up" and "Down" buttons.

2. If you have selected the specific date and recording timer set from that specific day to a new day, then the Recording Timer Schedule will be set as whole week. For specific date of Recording Timer Schedule, it is not recommended to set End Time over 23:59. For Example:If you set Timer Schedule Day as Sunday, and START from 11:30, but End on 00:20, then Recording Timer Schedule is set as from every Sunday's 11:30 to next Sunday's 00:20. If you only want to set Recording Timer Schedule from every Sunday 11:30 to Monday 00:20, then you should set Recording Timer Schedule as Sunday from 11:30 to 23:59, and Monday from 00:00 to 00:20.

### 2. START

Select the starting time for the recording.

### 3. END

Select the finishing time for the recording.

### 4. QUALITY

Select the image quality for the recording. There are four Quality settings : **BEST, HIGH, NORMAL and BASIC.**

### 5. IPS

Stand for Images Per Second and it could let you see Record submenu for more details.

**NTSC** - 25A、15、8、4、2、1

**PAL** - 18A、12、6、3、2、1

**NOTE** : "A" means "Record with Audio".

### 6. TIMER ENABLE

Enables / disables Timer recording function

```
(MENU)
SEARCH
▶ TIMER
RECORD
CAMERA
SYSTEM
EVENT
```

(TIMER)				
DAY	START	END	QUALITY	IPS
DAILY	00:00	00:00	BEST	25A
DAILY	00:00	00:00	BEST	25A
DAILY	00:00	00:00	BEST	25A
DAILY	00:00	00:00	BEST	25A
DAILY	00:00	00:00	BEST	25A
DAILY	00:00	00:00	BEST	25A
DAILY	00:00	00:00	BEST	25A
DAILY	00:00	00:00	BEST	25A
TIMER ENABLE : NO				

## RECORD

### 1. HDD OVERWRITE

Select "YES" to overwrite previous recording video in HDD.

**NOTE :** When the HDD is full under O/W Recording mode, previous recorded files may be overwritten without further warning notices.

### 2. RECORD IPS

Select the images per second of recording. The options are as following :

**NTSC** - 25A、15、8、4、2、1

**PAL** - 18A、12、6、3、2、1

**NOTE :** "A" means "Record with Audio".

### 3. RECORD QUALITY

There are four quality settings : BEST, HIGH, NORMAL and BASIC.

**NOTE :** The relationship of Record time, IPS and record quality, please refer to page.25 Recording Speed.

### 4. ALARM REC IPS

Select the images per second of recording during an Alarm. The options are as following :

**NTSC** - 25A、15、8、4、2、1

**PAL** - 18A、12、6、3、2、1

**NOTE :** "A" means "Record with Audio".

### 5. ALARM REC QUALITY

There are four quality settings during an Alarm : BEST, HIGH, NORMAL and BASIC.

**NOTE :** The relationship of Record time, IPS and record quality, please refer to page.25 Recording Speed.

### 6. MOTION TRIGGER RECORD

When you set up the MOTION DETECTION function (Please refer to Page.14 for MOTION DETECTION SETUP),

1. Select "ON" to set up the motion trigger record: It can automatically switch from stand-by mode to Record Mode. The motion detection will change the scanning sequence and shows  and "D" on the monitor.

**NOTE:** The trigger recording time will depend on ALARM DURATION mode setting (Please refer to page.11 for ALARM DURATION) and it will record from the last trigger time. For example, when the alarm duration setting is 1 min, the time recording time is from 9:00:00 to 9:01:00.

If the motion detection triggered again at 9:00:40, the triggered recording time will from 9:00:00 to 9:00:40 and 9:00:40 to 9:01:40. The total recording time is 00:01:40.

2. Select "OFF": The screen shows , the motion detection will change the scanning sequence while in record mode and shows "M" on the monitor.

(MENU)  
SEARCH  
TIMER  
▶ RECORD  
CAMERA  
SYSTEM  
EVENT

(RECORD)  
▶ HDD OVERWRITE: NO  
RECORD IPS: 25A  
RECORD QUALITY : NORMAL  
ALARM REC IPS: 25A  
ALARM REC QUALITY : HIGH  
MOTION TRIGGER RECORD: ON

## CAMERA

### 1. TITLE

Assign a title to each camera input. Initially each title is the camera's number.

### 2. DWELL

Select "ON" to set up the channel auto switching on the call monitor.

### 3. (Brightness) / (Contrast) / (Color)

Have a video adjustment (Brightness / Contrast / Color) of each channel. The level is from 0 to 9.

### 4. ALARM

Select LOW / OFF / HIGH for alarm polarity. The default value is LOW.

### 5. RECORD

Set up which channel you want to record during alarm trigger. The DVR record methods are as below :

**EVENT** : when alarm input is triggered, DVR will record alarming channel more frequently.

For example : when CH01 is triggered, the record method will become 1-2-1-3-1-4....

**NORMAL** : when alarm input is triggered, DVR will record normally as set up.

**OFF** : when alarm input is triggered, DVR will not record.

(MENU)  
SEARCH  
TIMER  
RECORD  
▶ CAMERA  
SYSTEM  
EVENT



## MOTION DETECTION

MOTION DETECTION SETUP 

1. Press "MENU" to enter the menu set up, then "Down" to CAMERA setup.
2. Press "ENTER" twice to enter the  Motion Detection Setup.
3. Each screen displays the current camera picture overlaid with the motion targets (as Figure 1).  
You can push the button "Left" or "Right", "Up" or "Down" to adjust motion detection in ON or OFF.
4. The targets on each motion setup can be turned to ON or OFF individually. To set up targets, using the front panel buttons:
  - Press "ENTER" to confirm the channel
  - Press "ENTER" to enter motion mode
  - ▲ Up -- moves the target cursor up one row at a time.
  - ▼ Down -- moves the target cursor down one row at a time.
  - ◀ Left -- moves the target cursor left one column at a time.
  - ▶ Right -- moves the target cursor right one column at a time.
  - Press "ENTER" to turn the target cursor ON and press "ENTER" again to turn the target cursor OFF. (Figure 1-1)
  - Zoom – turns all targets in the current row ON or OFF. (Figure 1-2)
  - PIP – turns all targets on the screen ON or OFF. (Figure 1-3)
5. Press "SLOW" button to setup the Sensitivity list up to 255 and "REC" button to setup the Sensitivity list down to 000.  
The default value is set on 32.

**NOTE : Sensitivity value is related to motion and brightness change. Low value (as 001) means higher sensitivity on motion and brightness change. High value (as 255) means lower sensitivity on motion and brightness change. User can choose the suitable sensitivity value in different locations.**

**NOTE :** When motion trigger record setting is ON, it can automatically switch from stand-by mode to record mode. The motion detection will change the scanning sequence and shows  on the monitor. There will be an action as following:

For example : If the motion is detected on Camera #1, its recording & scanning sequence will be more frequently. The sequence will be as 1st, 2nd, 1st, 3rd, 1st, ... 16th. And channel 1 will show  on the screen. If 2nd camera and 3rd camera both motion detection are activated, they will be scanning as 1st, 2nd, 3rd, 2nd, 2nd, 3rd, 3rd, 2nd, 3rd, 4th, 2nd, 3rd ... and vice versa. And CH2 & CH3 will show  for a period of time which is same as Alarm Duration time.









## OPERATION OPTIONS

### SELECT

This device allows user to get the ideal view size.

- Press , ,  button to make different view size.
- Press " Select " then " Left " or " Right " button to locate the desired position.
- Press " Camera Select (1-16) " to select the appointed camera.
- Press " Menu " to exit.

### PICTURE IN PICTURE (PIP)

Press PIP  button to enter PIP display screen. The PIP format displays a full screen "background" picture with a 1 / 16 size screen "insert".

- Press  button to move the insert screen.
- Press "Select" button to confirm the camera selection.
- Press "Left" or "Right" to choose background or insert screen.
- Press camera select (1-16) to select appointed camera into screen.
- Press "Menu" to exit.

### ZOOM

Press ZOOM button to enlarge the display of main picture. It displays zoomed picture on main picture and a small window inserted. The inserted window contains a movable 1/4 view size of the appointed camera.

- Press the appointed "Camera Select (1-16)".
- Press "Zoom" button to select zoom mode.
- Press the "Zoom" button again to move the zoom pointer.
- Press "Menu" to exit.

### VIDEO LOSS

Screen will display  if the video input is not connected properly.

## KEY LOCK

For further security, you can "Lock" all buttons on your DVR. Locking disables the buttons and prevents other people from using the system.

Press ENTER and MENU at the same time to enable Key Lock.

Press ENTER and MENU at the same time and key in password (Default : 0000), then press "ENTER" to disable Key Lock.

## RS232 REMOTE PROTOCOL

You can use the PC keyboard to simulate DVR keypad.

DATA: REMOTE PROTOCOL using 8 bit data, 1 start bit, 1 stop bit

FUNCTION	CODE	ASCII	FUNCTION	CODE	ASCII
KEY_MENU	0x4D	M	KEY_CH1	0x31	1
KEY_SELECT	0x73	s	KEY_CH2	0x32	2
KEY_ENTER	0x0D	ENTER	KEY_CH3	0x33	3
KEY_4CUT	0x61	a	KEY_CH4	0x34	4
KEY_ZOOM	0x5A	Z	KEY_CH5	0x35	5
KEY_9CUT	0x62	b	KEY_CH6	0x36	6
KEY_PIP	0x70	p	KEY_CH7	0x37	7
KEY_16CUT	0x63	c	KEY_CH8	0x38	8
KEY_SLOW	0x53	S	KEY_CH9	0x39	9
KEY_REC	0x72	r	KEY_CH10	0x41	A
KEY_LEFT	0x4C	L	KEY_CH11	0x42	B
KEY_UP	0x55	U	KEY_CH12	0x43	C
KEY_PLAY	0x50	P	KEY_CH13	0x44	D
KEY_DOWN	0x4E	N	KEY_CH14	0x45	E
KEY_RIGHT	0x52	R	KEY_CH15	0x46	F
KEY_POWER	0x57	W	KEY_CH16	0x47	G
KEY_KEY_LOCK	0x4B	K			

## TROUBLE SHOOTING

When malfunction occurs with DVR, it may be not serious and can be corrected easily. The table below describes some typical problems and their solutions. Please check them before calling your DVR dealer.

PROBLEM	SOLUTION
HDD Not Found	<ul style="list-style-type: none"> <li>● Please Insert HDD</li> <li>● Please use the Key to lock the HDD Cartridge</li> </ul> And press any key
No power	<ul style="list-style-type: none"> <li>● Check power cord connections.</li> <li>● Confirm that there is power at the outlet.</li> </ul>
Not working when press any button	<ul style="list-style-type: none"> <li>● Check if it is under Key Lock mode.</li> <li>● Press "MENU" &amp; "ENTER" to exist Key Lock mode.</li> </ul>
No recorded video	<ul style="list-style-type: none"> <li>● Check if the HDD is installed properly.</li> </ul>
Timer Record enable does not working	<ul style="list-style-type: none"> <li>● Check if the Record Enable is set to YES</li> </ul>
No live video	<ul style="list-style-type: none"> <li>● Check camera video cable and connections.</li> <li>● Check monitor video cable and connections.</li> <li>● Confirm that the camera has power.</li> <li>● Check camera lens setting.</li> </ul>

## SPECIFICATIONS

Video format	NTSC/EIA or PAL/CCIR
Hard disk storage	IDE type, UDMA 66, supported over 200GB HDD
Record mode	Manual / Alarm / Timer / Motion
Camera Input Signal	Composite video signal 1 Vp-p 75 $\Omega$ BNC, 16 channels
Camera Loop Back	Composite video signal 1 Vp-p 75 $\Omega$ BNC, 16 channels
Main Monitor Output	Composite video signal 1 Vp-p 75 $\Omega$ BNC
Call Monitor Output	Composite video signal 1 Vp-p 75 $\Omega$ BNC
Audio input	4 audio inputs, (RCA) *
Audio output	2 audio outputs, (RCA) **
Motion Detect Area	15 * 12 targets per camera (NTSC) / 15 * 14 targets per camera (PAL)
Motion Detect Sensitivity	256 Levels
Video Loss Detection	Yes
Refresh Rate	Up to 72 images/sec. for NTSC / 60 images/sec. for PAL
Recording Rate	Up to 25 images/sec. for NTSC / 18 images/sec. for PAL
Dwell Time	Programmable (1~10 Sec)
Picture in Picture	Yes (Movable)
Key Lock	Yes
Picture Zoom	2*2 (Movable)
Camera Title	6 letters
Video Adjustable	Color/ Contrast/ Brightness Adjustable
Alarm Input	TTL input, Hi (5V), Low (GND)
Alarm Output	COM,/N.O
Remote Control	RS-232 or RS-485
Time Display Format	YY/MM/DD, DD/MM/YY, MM/DD/YY, OFF
Power Source	AC100~240V + 10% switching adaptor
Power Consumption	<45W
Operation Temperature	10 ~ 40 $^{\circ}$ C
RS-232C / RS-485 (bps)	115200 57600 19200 9600 4800 3600 2400 1200
Dimension (mm)	432(W) x 110(H) x 325(D)
Net Weight	5.7 kgs

*Specifications are subject to change without notice.*

\* 4 audio inputs, but only can select 1 during operation for recording

\*\* with 2 mono audio outputs from the same source.

## APPENDIX #1 – INSTALLING the HDD

Please follow the next steps carefully in order to ensure correct installation.

The compartment located on the front panel of the DVR is the removable Cartridge Casing in which you insert the HDD. The various parts of the Cartridge Casing are labeled for your reference.

### 1. Remove the Cartridge Casing from the DVR

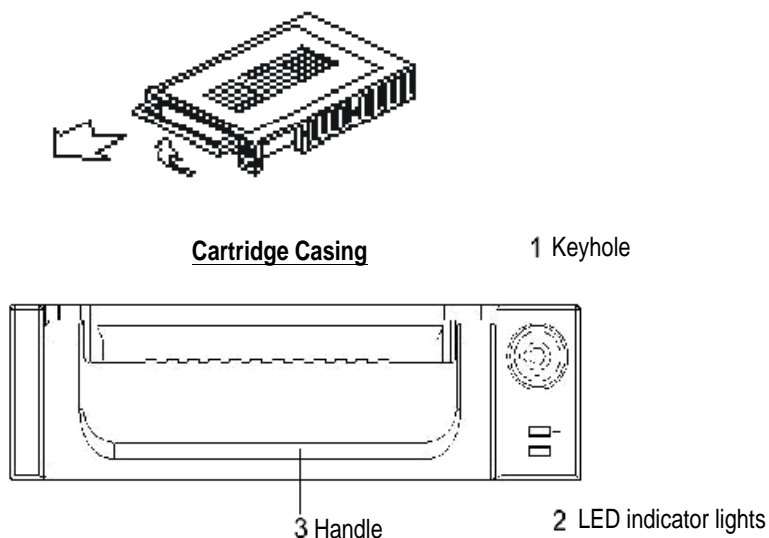

### 2. Remove the Cover from the Cartridge Casing

- Unclip the release latch with the word "OPEN" printed beside it by gently pushing on the latch.
- Slide the cover off the Cartridge Casing.

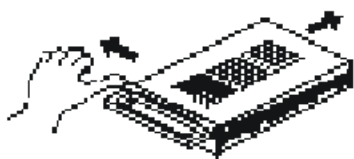

### 3. Connect the HDD into the Cartridge Casing

Please take the Hard Disk Drive and Connect the two cables from the back of the Cartridge Casing to the HDD.

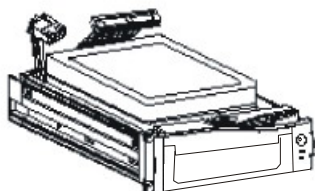

#### 4. Secure the HDD in the Casing (optional)

Use the supplied screws and tighten them, positioning the HDD into place.

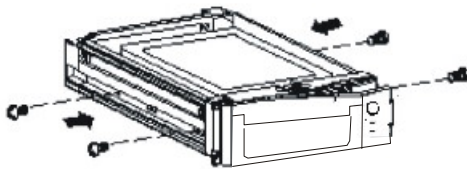

#### 5. Slide the top Cover over the Cartridge Casing

Slide the Cover forward over the Cartridge Case. Ensure it is secured in place over the release latch.

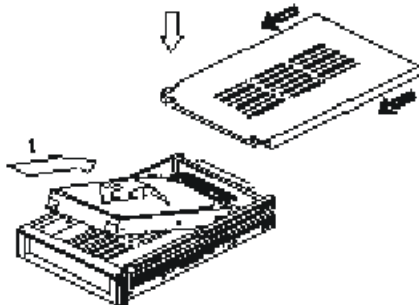

#### 6. Reinsert the Cartridge Casing into the DVR

Fully insert the Cartridge Case into the DVR.

#### 7. Lock the Cabinet

Lock the cabinet by turning the key clockwise.

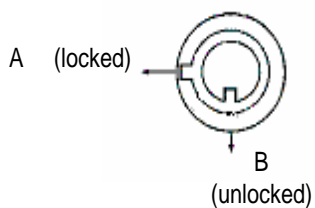

**Note :** If you do not lock the cabinet, the DVR system will not function properly.

1. If two HDDs are set up, one should be selected as " Master " and another should be selected as " Slave".
2. This product does not support hot swap. Please power off the unit before removing HDD.
3. Approved models and manufactures of HDD listed in page.4 have been tested and proven compatible with this appliance.
4. Please remove hard disk drive ONLY after power was shut off for more than 60 seconds. This would protect and extend the operating life of the hard disk drive.
5. Master or Slave HDD should be set up by selecting HDD Jumper.

# APPENDIX #2 – PIN CONFIGURATIONS

## 25 pin com port

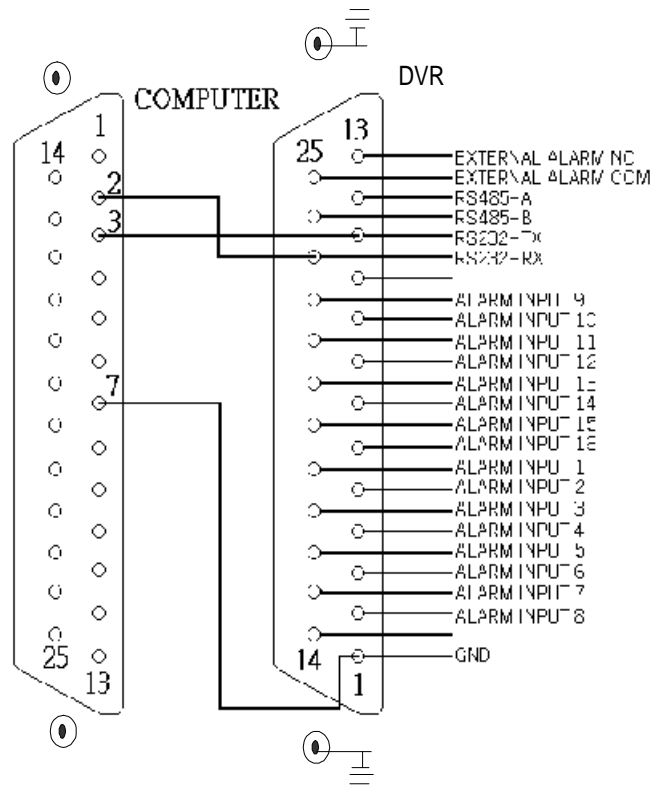

## 9 pin com port

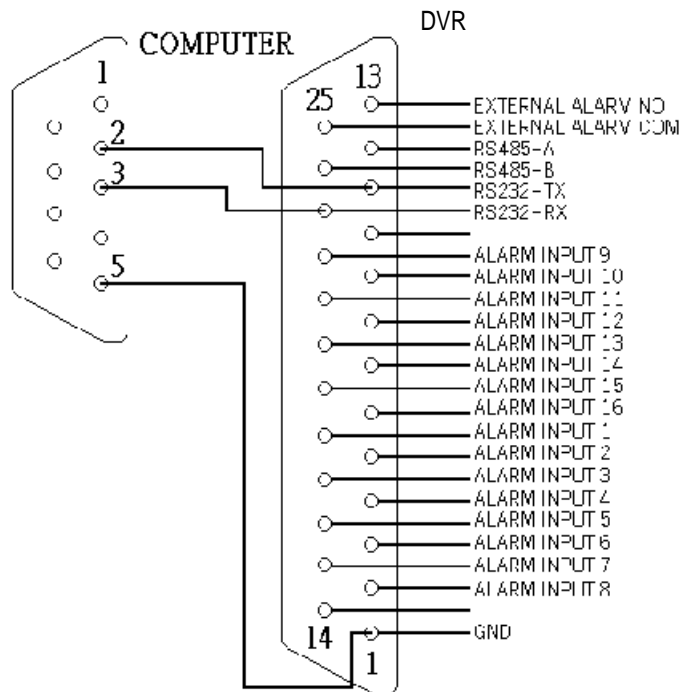

**PIN 1. GND**

GROUND

**PIN 2. — PIN 9. ALARM INPUT**

To connect wire from **ALARM INPUT ( PIN 2 -- 9 )** to **GND ( PIN 1 )** connector, DVR will start recording and buzzer will be on.

When Menu/ Camera/ Alarm is set up to "Low" : When alarm input signal is " Low ", the unit starts to record and buzzer.

When Menu/ Camera/ Alarm is set up to "High" : When alarm input signal is " High ", the unit starts to record and buzzer.

**PIN 10. PIN OFF****PIN 11. RS232-TX**

DVR can be controlled remotely by an external device or control system, such as a control keyboard, using RS-232 serial communications signals.

**PIN 12. RS485-A**

DVR can be controlled remotely by an external device or control system, such as a control keyboard, using RS485 serial communications signals.

**PIN 13. EXTERNAL ALARM NO**

Under normal operation COM disconnect with NO. But when Alarm triggered, COM connect with NO.

**PIN 14. PIN OFF****PIN 15. — PIN 22. ALARM INPUT**

To connect wire from **ALARM INPUT ( PIN 15 -- 22 )** to **GND ( PIN 1 )** connector, DVR will start recording and buzzer will be on.

When Menu/ Camera/ Alarm is set up to "Low" : When alarm input signal is " Low ", the unit starts to record and buzzer.

When Menu/ Camera/ Alarm is set up to "High" : When alarm input signal is " High ", the unit starts to record and buzzer.

**PIN 23. RS232-RX**

DVR can be controlled remotely by an external device or control system, such as a control keyboard, using RS-232 serial communications signals.

**PIN 24. RS485-B**

DVR can be controlled remotely by an external device or control system, such as a control keyboard, using RS485 serial communications signals.

**PIN 25. EXTERNAL ALARM COM**

Under normal operation COM disconnect with NO. But when alarm triggered, COM connect with NO.



## APPENDIX #3 – RACK MOUNT

Screws and brackets for rack mounting applications can be purchased as an optional accessory.

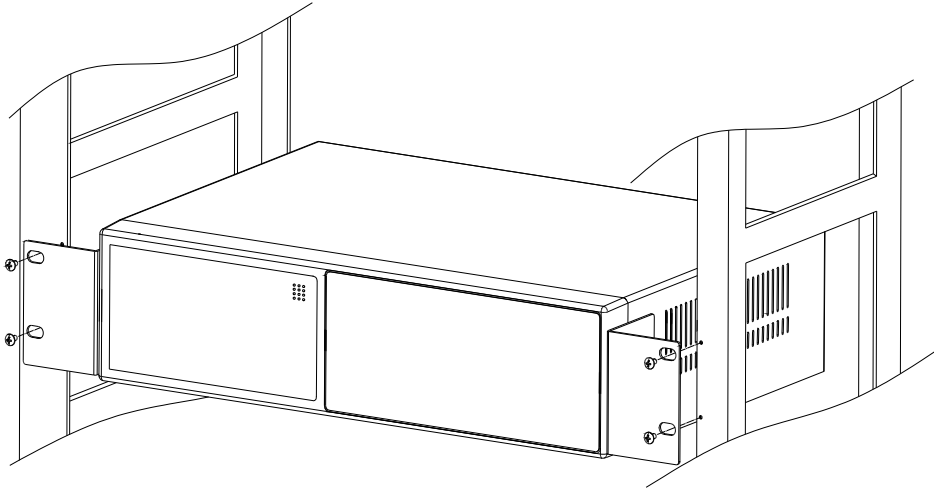

Front Angle with Rack Mount

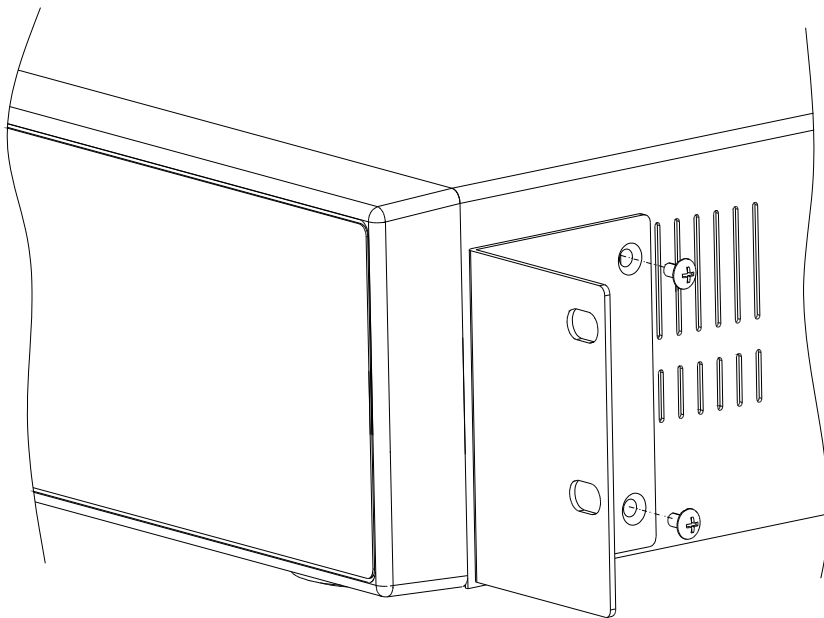

Side View with Rack Mount

## APPENDIX #4 – RECORDING SPEED

The Record Time is different based on Record Speed and Record Quality. Please refer to following table.

### NTSC SYSTEM

IPS		25A	15	8	4	2	1
Record Quality	Best	48hr	96hr	180hr	360hr	720hr	1440hr
	High	60hr	120hr	226hr	450hr	900hr	1800hr
	Normal	96hr	192hr	360hr	720hr	1440hr	2880hr
	Basic	160hr	320hr	600hr	1200hr	2400hr	4800hr
HDD Type		240GB (120GB X 2)					

### PAL SYSTEM

IPS		18A	12	6	3	2	1
Record Quality	Best	48hr	100hr	202hr	406hr	608hr	1216hr
	High	60hr	126hr	254hr	506hr	760hr	1520hr
	Normal	98hr	202hr	406hr	810hr	1216hr	2440hr
	Basic	162hr	336hr	676hr	1350hr	2026hr	4050hr
HDD Type		240GB (120GB X 2)					

*Note: Above data is from actual test data obtained from recording normal TV program. (Reference only)*